

## INFRARED PERIMETER POOL ALARM SYSTEM

PRIMAPROTECT

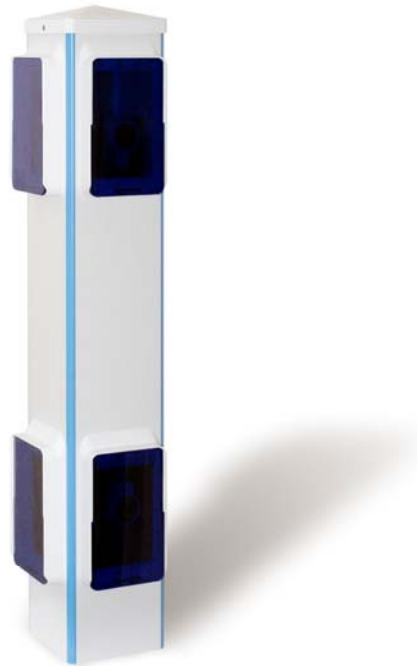

# User and Installation Notice

To read attentively and to conserve for further consultation

**The alarm system Primaprotect is AFNOR NF P 90-307 compliant.**

**This alarm system does not replace neither the common sense nor the individual liability. Its purpose is not to replace the vigilance of the parents and/or the responsible adults, which remains the main factor of protection of children under five years old.**



## **WARNING**

**A WRONG POSITIONING OR A NON CONFORM INSTALLATION MAY CAUSE DYSFUNCTIONS OF THE ALARM SYSTEM**

**PLEASE READ CAREFULLY THIS NOTICE BEFORE PUTTING THE SYSTEM INTO SERVICE**

- 1- The content of this booklet may be subject to changes without any prior notice.
- 2 – Due to printing restrictions the symbols displayed in this manual can differ from the ones in the product.
- 3 – The content of this booklet cannot be reproduced without the authorization of the manufacturer.

## Table of contents

1	FUNCTIONAL DESCRIPTION OF THE PRIMAPROTECT ALARM SYSTEM	4
2	COMPONENTS OF THE KIT :	4
3	INSTALLATION	6
3.1	Positioning the posts:	6
3.2	Limits regarding the positioning of the posts	7
3.3	Preparing and mounting the posts	8
3.4	Plugging the batteries	8
3.5	Matching and aligning the infrared beams	9
4	UTILISATION	11
4.1	Arming / Disarming the alarm system	11
4.2	Shutting off the siren	12
4.3	Shutting down the system	12
5	DIFFERENT CONFIGURATIONS OF PROTECTION	12
6	ACCESSORIES (provided in option)	15
6.1	Recognition of the accessories by the master post	15
6.2	Sensor bracelet	16
6.3	Remote	17
7	FAILURES	18
7.1	Weak battery indicator of the posts	19
7.2	Weak battery indicator of the accessories	19
8	MAINTENANCE	19
8.1	Changing the batteries of the safety bracelet	20
8.2	Changing the batteries of the remote	20
8.3	Cleaning the panes	21
8.4	Cleaning the bracelet	21
9	Interpretation of the sounds and visual signals of the alarm system	21
10	Guarantee, responsibility	22
11	Safety notice	24
12	Technical characteristics	26
13	WASTE COLLECTION FOR ELECTRONIC EQUIPMENTS AND BATTERIES	27

## 1 FUNCTIONAL DESCRIPTION OF THE PRIMAPROTECT ALARM SYSTEM

The perimeter alarm system Primaprotect detects any crossing of the infrared beams by a child. The infrared beam is positioned in two different heights in order to form two protected areas: One at 20 cm and the other one at 45 cm from the ground.

You can add various extra features to the Primaprotect alarm system such as (see § 6) :

- A remote control or a remote keypad with a digit security code
- A safety bracelet that detects the fall into the water of the child that wears it. It is highly recommended as an extra safety device when the barrier alarm system is deactivated.
- A wireless gate sensor, which triggers a series of “beeps”, if the entrance gate to the pool, the door or the window of your residence is opened.

## 2 COMPONENTS OF THE KIT :

It is advisable to check that the kit is complete and that you have all the following items :

- A master post and three slave posts.
- A fixation Kit (inside each post)
- A bag containing a magnetic key, the user and installation notice, the LNE Certificate of Conformity, the guarantee and the operation sheet (to return back to us).



Figure 1 : Magnetic key

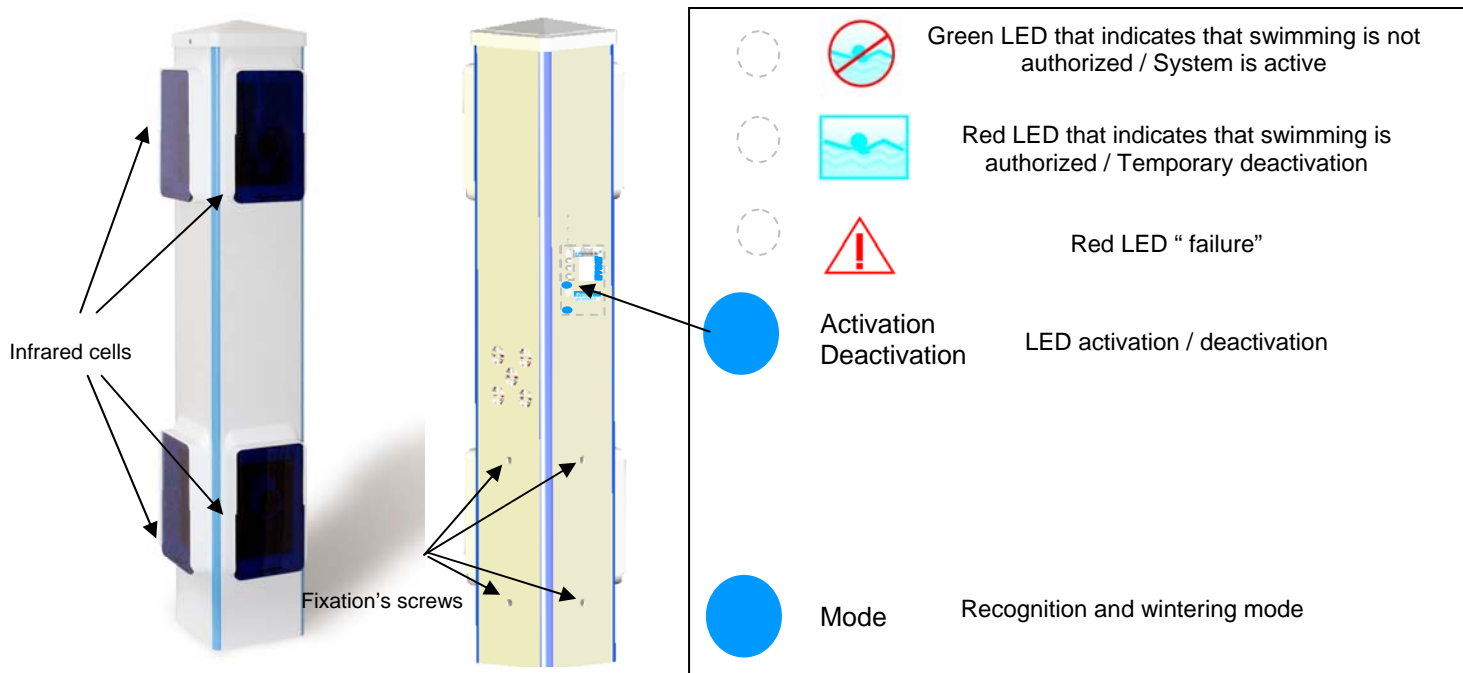

Figure 2 : The exterior of the master pole

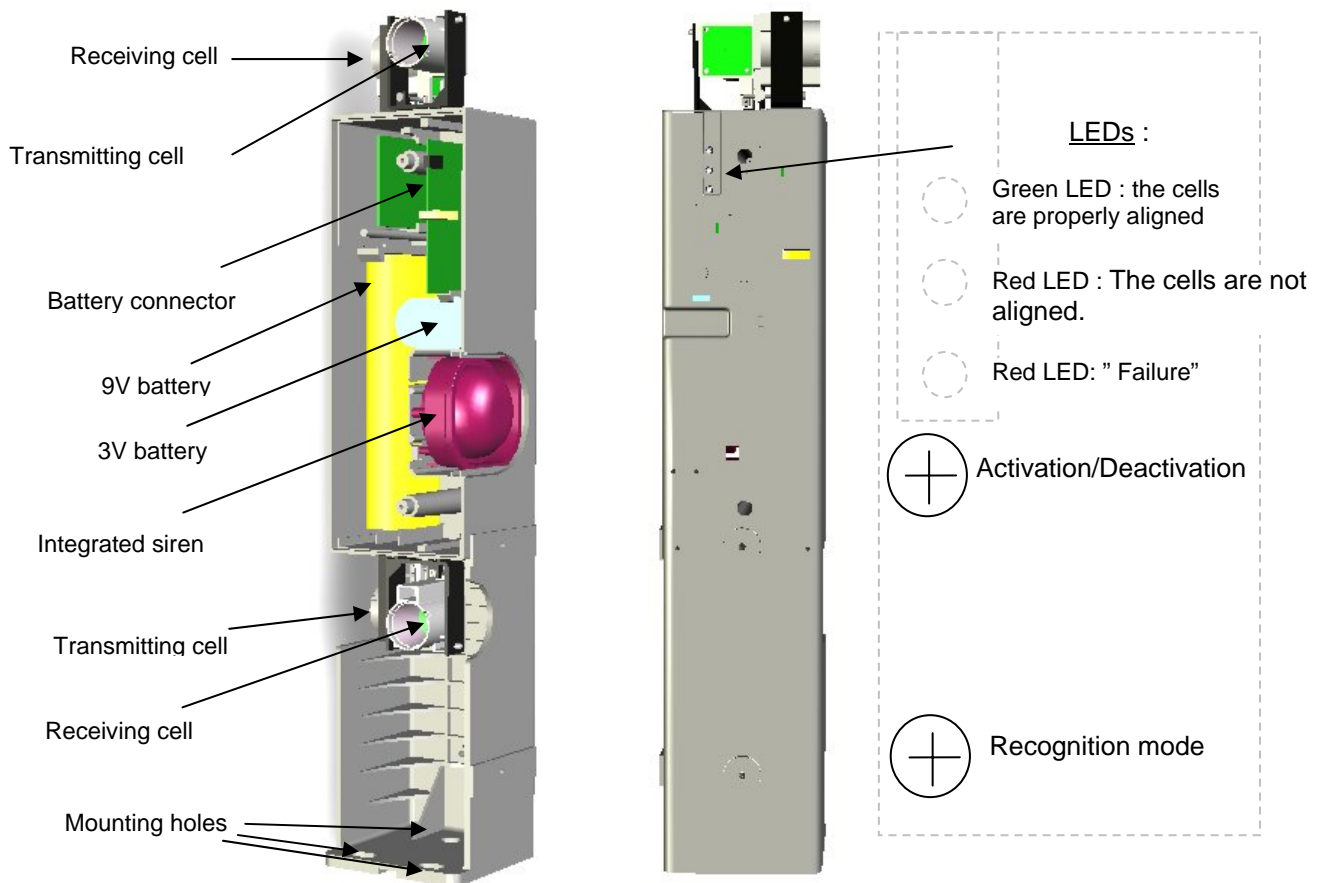

Figure 3 :Inside of the master pole

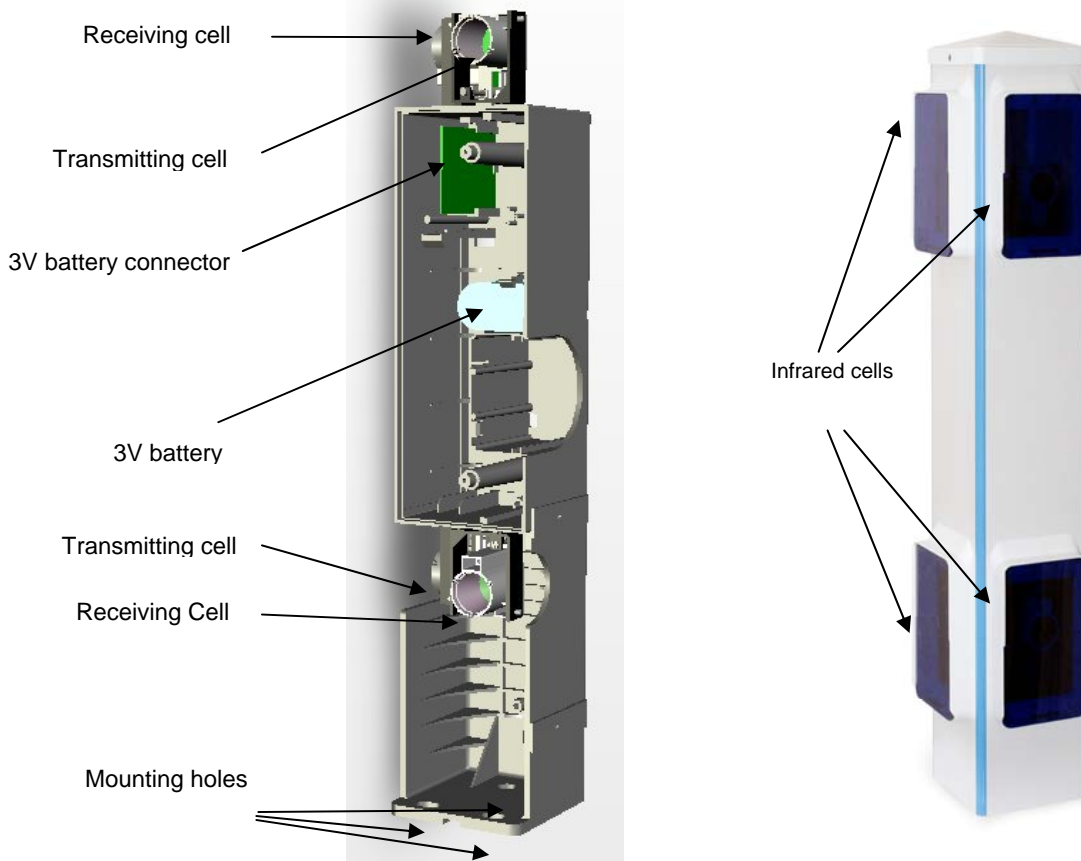

Figure 4 : Composition of the slave post

### 3 INSTALLATION

A correct installation is imperative for a good operation of the system. Read carefully the following instructions.

**NB : It is advised to have a professional install and maintain your alarm system.**

Your central unit Primaprotect must be installed in such way that it can not be moved with bare hands (without appropriate tools).

Use an adapted drill with a 12 mm diameter bit, an electric or a regular Phillips screwdriver

**For your installation, do not start drilling right away.**



Illustration 5 :Tools needed for your installation

#### 3.1 Positioning the posts:

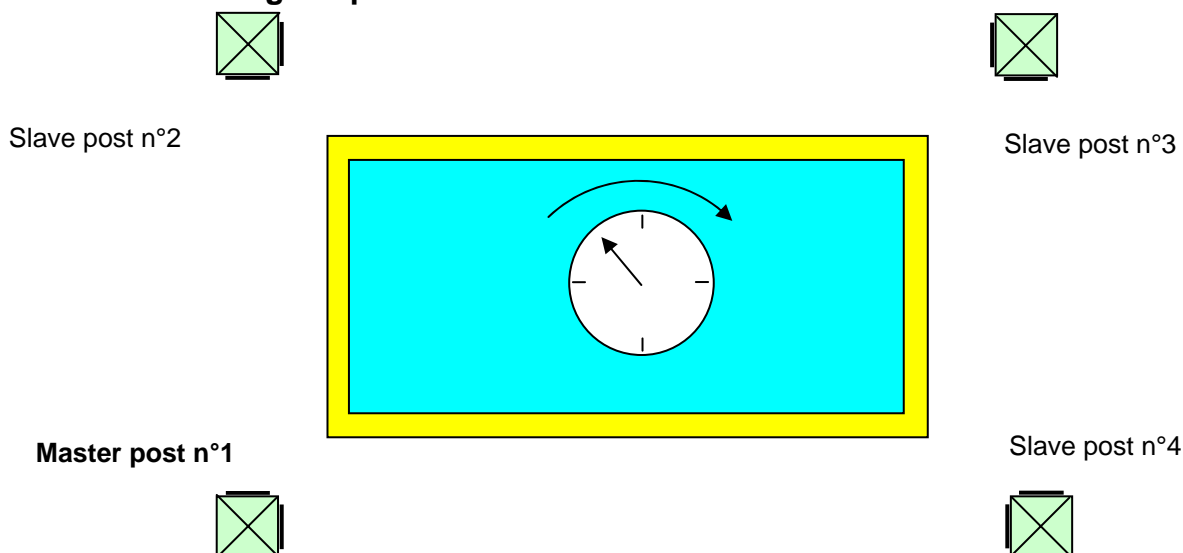

Illustration 6 : Example of installation around a rectangular swimming pool

Position the master post n°1 and slave posts n°2, n°3 and n°4 clockwise as indicated in the drawing above. The number corresponding to the post is indicated on the top of the post , next to the cells.

Each post comprises 4 windows behind which the transmitting and receiving infrared cells are located. Make sure that the infrared cells are facing each other as shown in the drawing above.

The maximum distance between two posts cannot exceed 20m and cannot be inferior to 3m.

### 3.2 Limits regarding the positioning of the posts



#### **Warning**

A wrong installation may cause dysfunctions of the system which represents a real danger to the safety of your child.

Do not expose the posts too close to a reflecting surface (minimum 1.5m). Whichever season it is do not let any vegetation cut through the infrared beams.

While using the safety bracelet, the maximum distance between the master post and the furthest possible location of fall of your pool, cannot exceed 30m. The range of the alarm system depends on the pool environment.

For an optimum efficiency, there should be no obstacle in between the master post and the edges of the pool (Wall, tree, etc).

The posts must be fixed on a flat ground preferably in concrete with a flatness of more or less 1 cm. Avoid the following configurations :



Figure 7 : Configurations to avoid

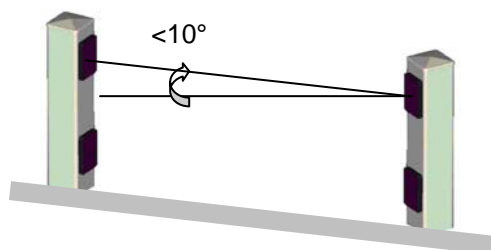

Figure 8a : Vertical positioning

The slope of the ground can not exceed  $10^\circ$ .

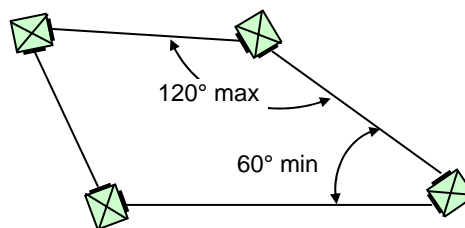

Figure 8b : Horizontal positioning

The posts must be positioned, one according to the others, with a minimum angle of  $60^\circ$  and inferior to  $120^\circ$ .

### 3.3 Preparing and mounting the posts

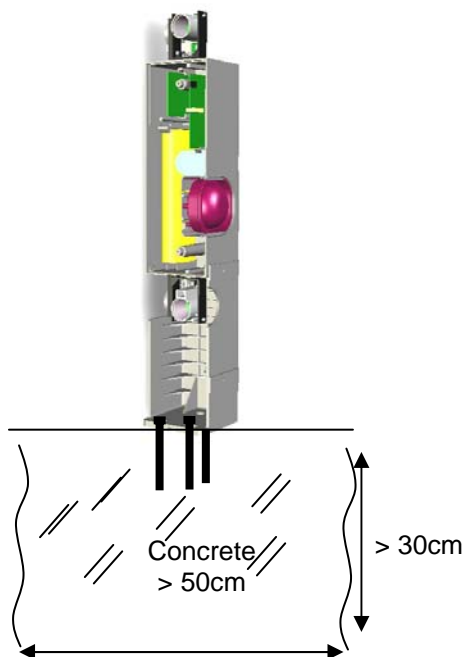

Illustration 9 : Mounting the posts.

Remove the four screws from the bottom of the posts and use the anchor bolts provided with the kit to mount them. Sealing the posts must be carried out carefully

To obtain the best resistance of the posts, it is advised to mount the fastening bracket with an anchor bolt of at least 800x10 mm. The drilling diameter is 12 mm.

### 3.4 Plugging the batteries

Plug the 9V then 3V battery packs to the master post as shown below. The siren emits a beep and the LEDs light up (the LEDs of the two receiving cells start blinking and the middle red LED of the master post light up continuously (see illustration 3) .

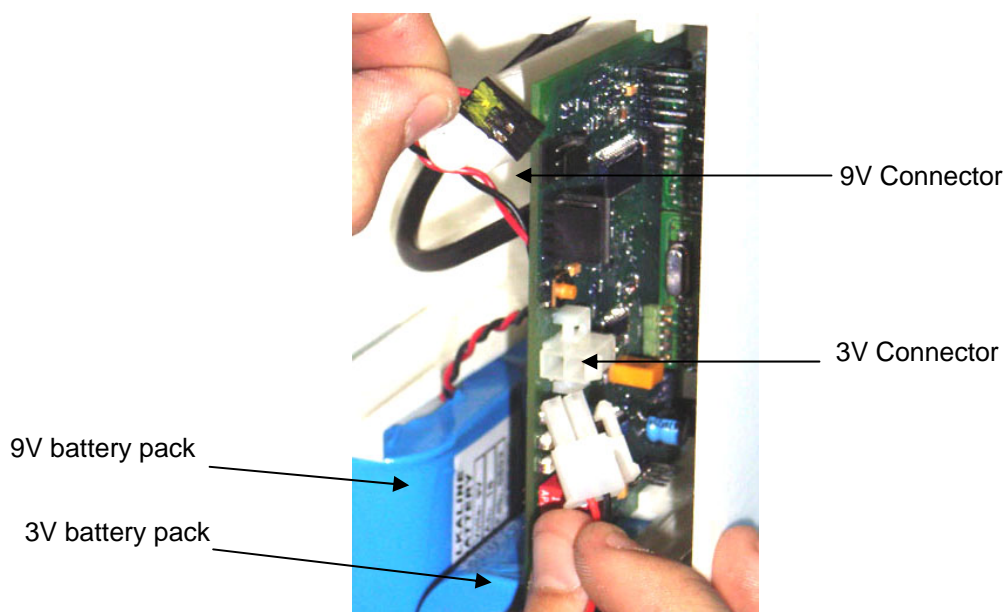

Figure 10 : Plugging the batteries to the master post.



Plug the battery pack to the slave post as shown below. The LEDs of the two receiving cells light up.

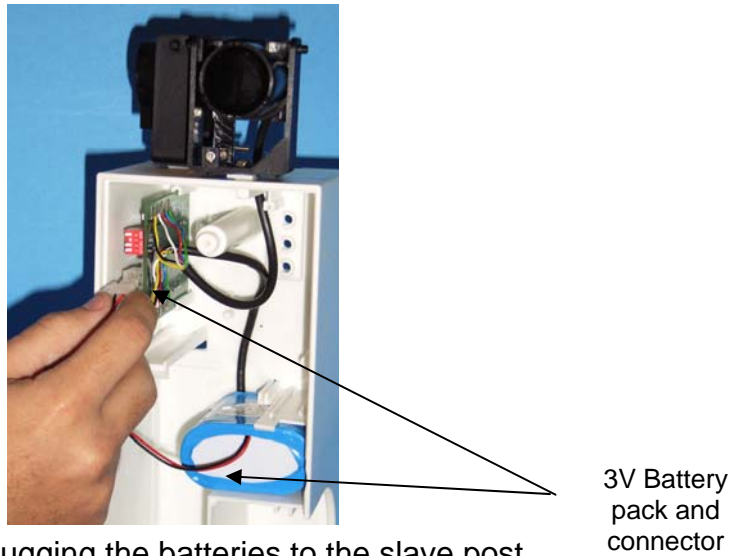

Figure 11 : Plugging the batteries to the slave post.

### 3.5 Matching and aligning the infrared beams

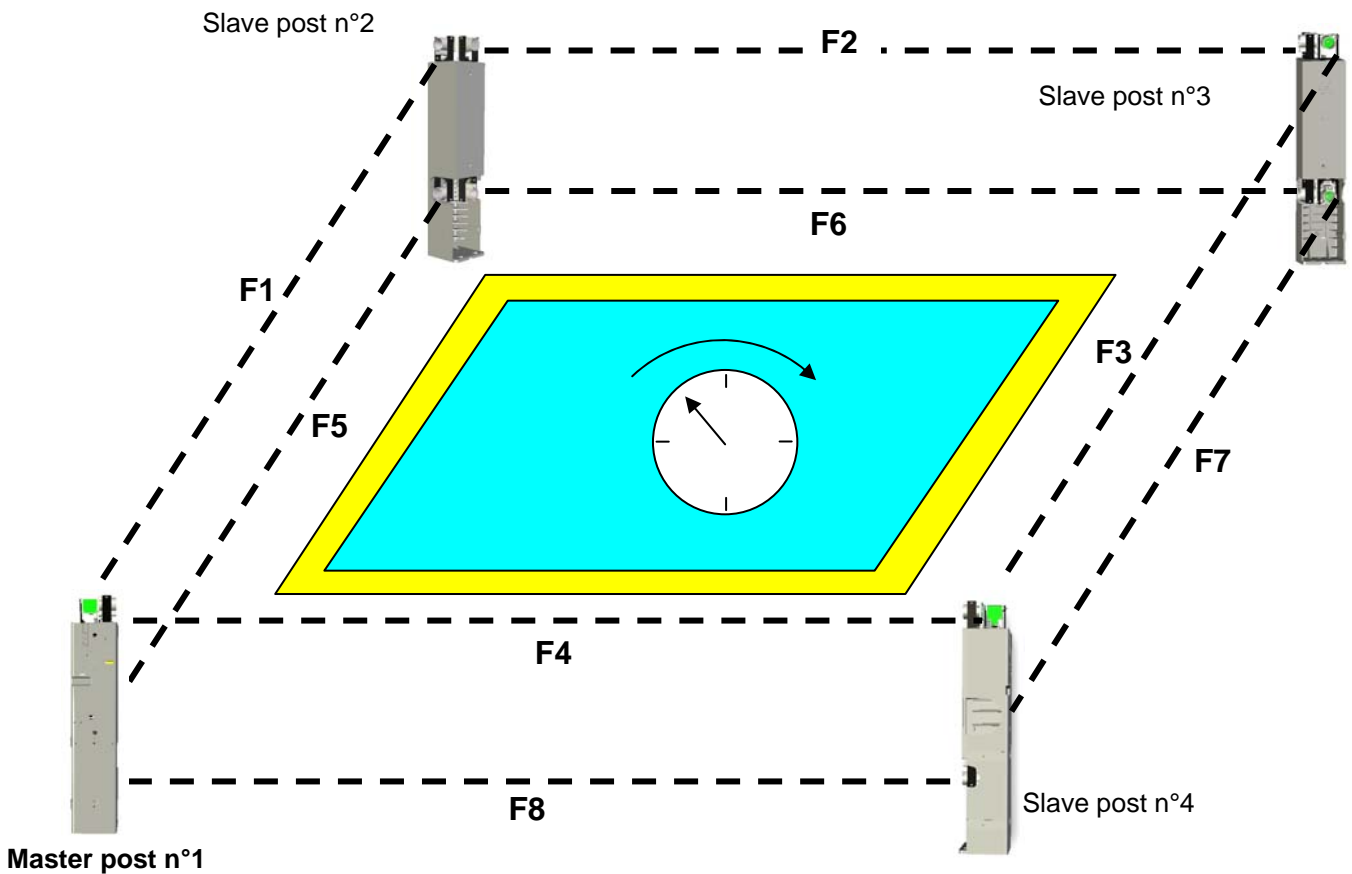

Figure 12 : Example of setting around a rectangular pool

The cells must be oriented horizontally ( $\pm 15^\circ$ ) according to the setting of the posts around the basin and vertically in case of a slope of the ground ( $\pm 10^\circ$ )  
The alignment procedure consists of aligning each transmitting cell of the infrared beam of a post toward the receiving cell of the post placed in front of it.

When the batteries are plugged, the red LEDs of the receiving cells of each post light up. Follow the procedure below:

- 1 – Remove any obstacle which might be in the way of the beams' alignment.
- 2 – Start with the high beam F1 (see illustration 12)
- 3 – Make sure that the transmitting cell is properly oriented towards to the receiving cell located at the same height.

- When the receiving cell is properly aligned towards the transmitting cell, the red LED of the receiving cell lights up continuously.
- If the red LED of the receiving cell flashes, it means that it is not receiving the IR beam. In that case, redirect the transmitting cell and then the receiving cell as shown in the illustration 13 until the red LED lights up continuously.

4 – **Position the optical filter** on the receiving cell as indicated in illustration 13. The red LED of the receiving cell must light up continuously. If it starts blinking, you need to sharpen the alignment of the cells.

5 – Repeat the same procedure successively for each high beam F2, F3 and then F4. This procedure must be carried out clockwise and the same way for the lower beams F5, F6, F7 and finally F8.

At the end of this procedure, if the green LED of the master post (refer to illustration 3) lights up continuously, the infrared beams are correctly aligned.

If the red LED of the master post lights up continuously, it means that at least one cell is not properly aligned. In that case, you must start over the procedure.

Once the procedure is completed, position the magnetic key on the reference mark "Activation / deactivation" of the post (see illustration 3). The system shuts itself down temporarily (red LED starts blinking). Mount the post's cover and the system is now operational. If you encounter any difficulty, please refer to § 9.



**WARNING :**

A proper operation of your Primaprotect alarm system depends on the alignment of the cells. The alignment procedure is mandatory when you first use the system. It must be carried out on all the beams of the installed system. Do not use the remote or the bracelet during the alignment procedure.

**VERY IMPORTANT:** The alarm system enters automatically into installation mode for 1h30mn after the batteries were plugged. This time is plenty enough for the installation of your Kit Primaprotect. Passing this delay the LEDs of the cells turn themselves off and you are no longer in "installation mode".

If you have not finished the alignment procedure during the allocated time, you can re-enter the installation mode by pushing the button on the card of the master post (see illustration 19).

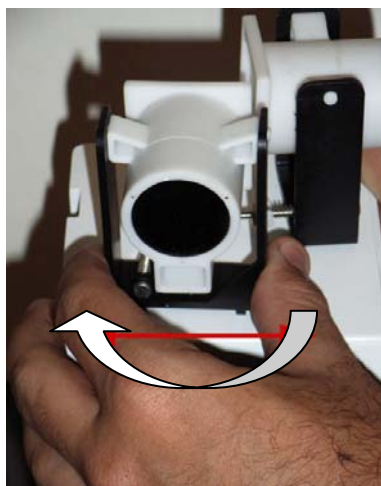

Figure 13a : Horizontal orientation

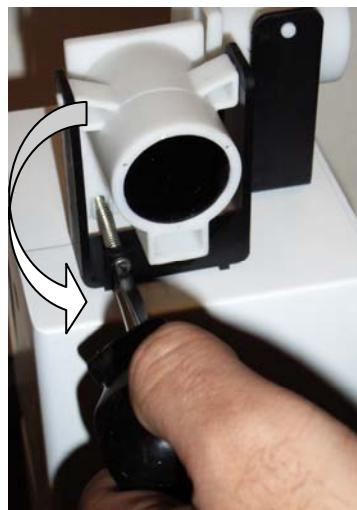

Figure 13b : Vertical orientation

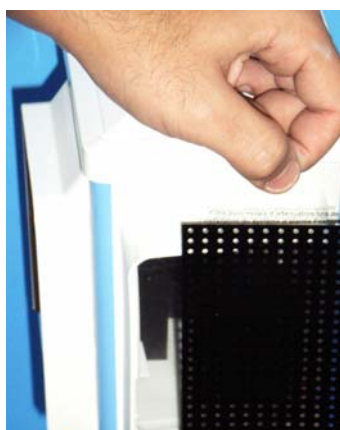

Figure 14 : Positioning the optical filter

## 4 UTILISATION

### 4.1 Arming / Disarming the alarm system

The system can be activated at any time with the magnetic key. Position the magnetic key against the reference mark « activation/deactivation » of the master post (see illustration 2). The post emits series of beeps and the green LED « Monitoring » starts blinking.

If it's not the case, and you hear a low beep instead, it means that an obstacle is cutting through one of the infrared beams around the pool. Make sure that no body and that no physical obstacle is around the posts.

In order to disarm the system, place the magnetic key against « activation/deactivation ». The post answers with a beep. The system is disarmed for 60 minutes if none of the infrared beam is crossed during that time. This time will be automatically prolonged as long as the infrared beams are being crossed.

You can also use the remote, optional feature of the kit, to arm and disarm the Primaprotect alarm system.

## 4.2 Shutting off the siren

The siren is triggered in the two following cases:

- One of the beams has been crossed while the alarm system was armed.
- Presence of an obstacle for a period of time of 60 minutes when the alarm system is disarmed.

If during a triggered state, you wish to shut off the siren, place the magnetic key against "activation/deactivation" of the master post or simply press any button of the remote (optional feature).

If the siren is not voluntarily turned off, it will automatically shut itself off after three minutes.

After the alarm went off, the system goes into the mode « temporarily shut off».



### **WARNING**

After installing your system, trigger your alarm. Make sure that you can hear the siren from any location of your home. If your pool is situated a long way from your home, it might be necessary to add an extra remote siren to your system (available as an option).

## 4.3 Shutting down the system

Shutting down the system for an indeterminate period of time, is not authorised unless the pool is protected by another certified device (cover, shutter...) or if you are not planning to use the pool for a long period of time.

There are three different ways to enter into "wintering mode":

- By maintaining simultaneously two magnetic keys against the reference marks « mode » and « activation / deactivation » for more than 10 seconds (the second magnetic tool is an optional feature to be added to your kit).
- By using the keypad (available as an option) and taping the code « 1 2 3 4 5 6 A » (original code).
- Unplug all the battery packs.

## 5 DIFFERENT CONFIGURATIONS OF PROTECTION

To ensure a full protection, all the segments must be :

- Either continuous (4 segments of protection around the pool).
- Either discontinuous (3 segments of protection around the pool) in conjunction with one physical element such as a wall, a façade of such size and shape that it prevents any crossing .... With a minimum height of 1,10 m between two supporting points. The physical element must comply with the Norm NF P 90 306.

The Kit DSP80-F4 is provided for a classical configuration of protection of 4 sides or segments of the pool. You can select the area to protect 3, 2 and 1 segment by positioning the switches inside the posts as shown in the table below :

	Correct Positioning	Incorrect Positioning	Switch Master post N°1	Switch Slave post N° 2	Switch Slave post N° 3	Switch Slave post N° 4
Installation of 4 segments of protection Factory configuration						
Installation of 3 segments of protection						
Installation of 2 segments of protection						
Installation 1 segment of protection						



## 6 ACCESSORIES (provided in option)

The central unit of the Primaprotect alarm system can handle up to 16 radio accessories.

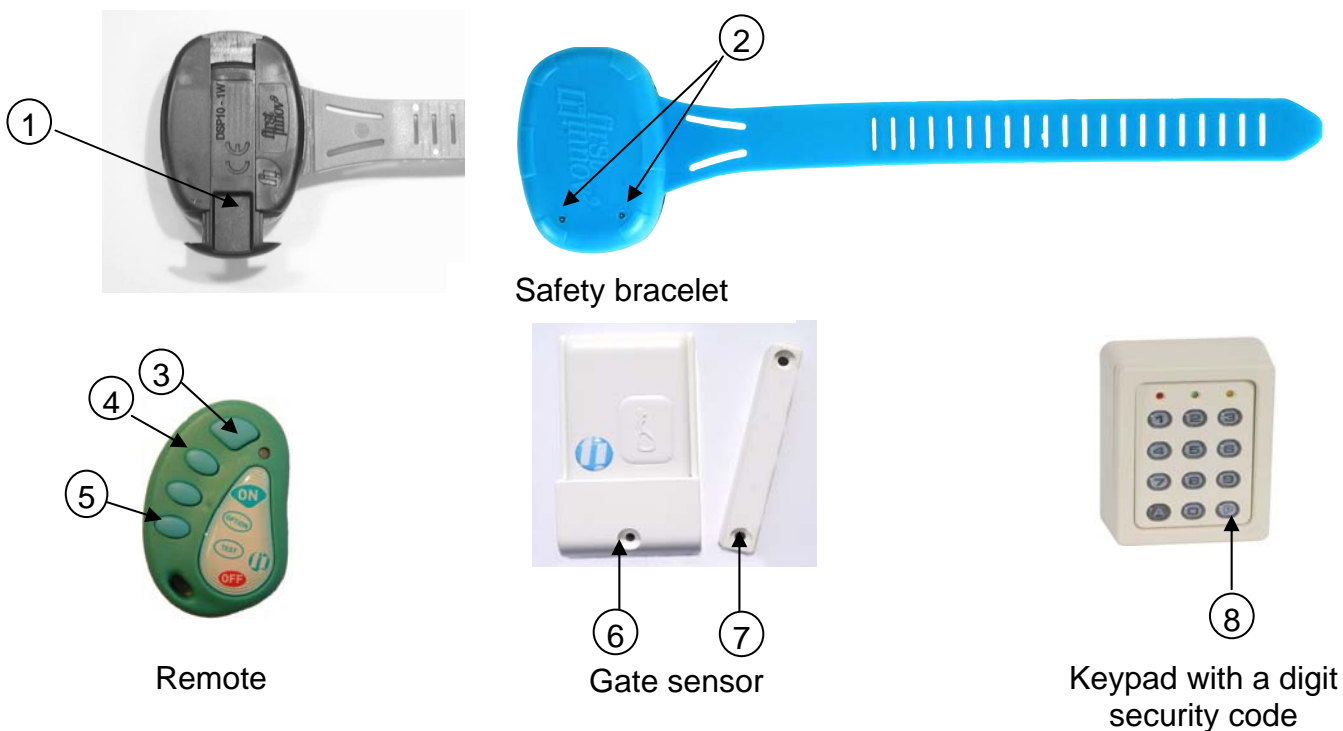

- 1 : Security clasp
- 2 : Electrodes of the bracelet
- 3 : Activation
- 4 : Recognition
- 5 : deactivation
- 6 : Detector
- 7 : Magnet
- 8 : P button

Figure 15 : Primaprotect Accessories

### 6.1 Recognition of the accessories by the master post

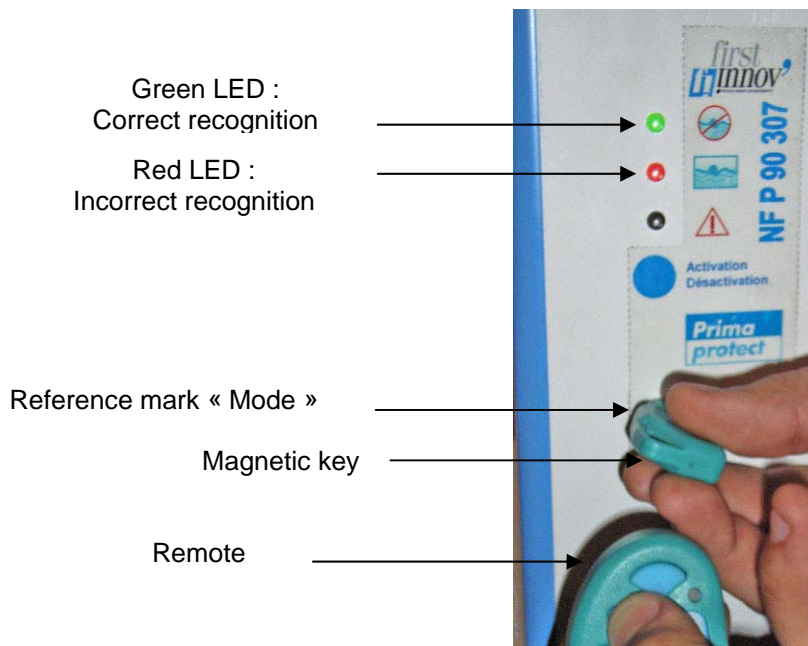

Figure 16 : Example of the recognition procedure for the remote

In order to have the accessories recognised by the post, follow the procedure below and repeat it for each accessory:

- Maintain the magnetic key against the reference « Mode » (see illustration 2), the red LED lights up continuously.
- Within the 20 following seconds, as long as the red LED is on and without retrieving the magnetic key proceed as follows according to the accessory to be recognised :
  - Remote : Press the button 4 (see illustration 15).
  - Bracelet : Dip the bracelet in a glass of water then pull it out of the water.
  - Keyboard : Simply press the « P » button.
  - Gate sensor : simulate a complete cycle « opening/closing » by pressing the magnet against the detector and then moving it away from it.

If the operation is successful, the central emits beeps and the green LED lights up. Withdraw the magnetic key. The accessory is ready to be employed.

## 6.2 Sensor bracelet

The safety bracelet is placed around the child's wrist. The bracelet detects the fall into the water thanks to its two electrodes (2) and transmits the information instantly by radio waves to the central unit of the master post, which triggers the siren. Each bracelet is equipped with a mechanical security clasp (1) to prevent voluntary or accidental removal.



### **WARNING :**

The bracelet is suitable for children under five years old. This safety device is incompatible with swimming pool with a high concentration of salt. The bracelet is operational even when the system is disarmed while swimming ( all the LEDs of the master post are OFF).

Once the system is installed and tested, simply place the bracelet around the child's wrist.

#### **6.2.1 Lock the safety bracelet around the wrist.**

Pinch the smaller end against the casing to release the catch, insert the strap into the slot underneath the bracelet body, and push tight. Then lock the clasp by sliding the tongue of the catch home until it clicks. It is necessary to carry out this handling simultaneously in order to slide the tongue.



Follow the steps below to fit the sensor bracelet around the wrist :



Insert the strap into the slot underneath the bracelet body and adjust it to the child's wrist. Do not put it on too tight.

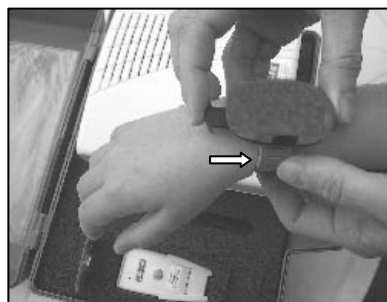

Lock the sensor bracelet.

Figure 17 : Locking the bracelet

### 6.2.2 Unlocking the sensor bracelet

To unlock the bracelet, pinch the smaller end against the casing to release the catch and slide the tongue out by pulling on the larger end. Then remove the strap by pulling gently. It is necessary to carry out step 1 and 3 simultaneously to slide the tongue out

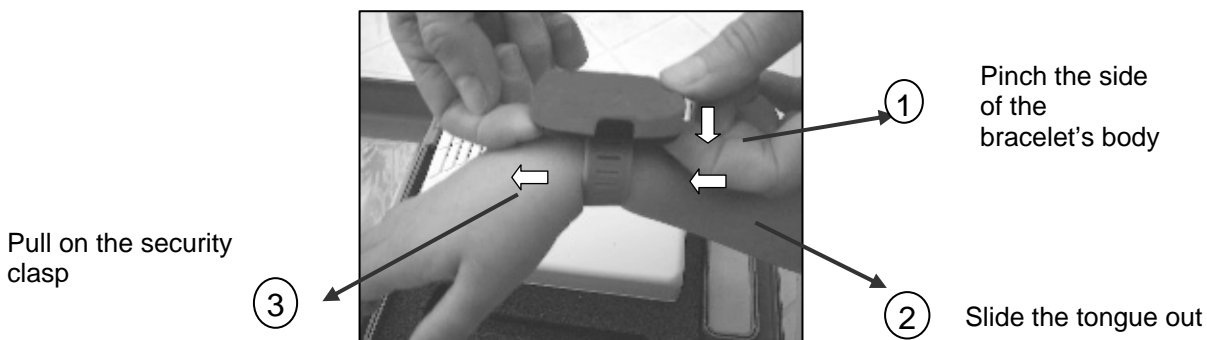

Figure 18 : Unlocking the bracelet

### 6.2.3 Testing the bracelet

Test the bracelet before each use. Dip the sensor bracelet into the water of the pool. The alarm goes off within two seconds following the immersion of the bracelet.

When the test of the range is valid, it is possible to renew the procedure from another location of the pool (as many times as necessary).

### 6.3 Remote

The remote enables you to arm and temporary disarm the alarm system from a distance. The alarm system Primaprotect can operate with the remote as soon as the recognition procedure has been carried out (§ 6.1). However the system can always be used with the magnetic key provided with the kit.

The alarm system can be activated at any time by pressing the button 3 (see illustration 15) of the remote.

The activation of the system is only possible if there is no obstacle in the alignment of one of the infrared beams. If it's not the case, the central emits a single low beep.

The deactivation is protected to prevent any intentional deactivation of the alarm system and to prevent a child from disarming it.

To deactivate the infrared beams, push the button 3 while maintaining the button 5 pressed.

The system is disarmed for 60 minutes after the last crossing of one of the infrared beams. After this delay, the alarm system rearm itself automatically. The master post emits a series of beeps and the green LED "Monitoring" starts blinking.

## 7 FAILURES

If a failure of the battery pack is detected, the red indicator LED "Failure" (see illustration 2) of the master post starts blinking and you can hear a short beep every 30 seconds. The replacement of the battery has to be done as soon as possible. In order to avoid this dangerous situation, the battery has to be replaced each year at the beginning of the season.

To identify the failure, dismount the master post and press the button of the electronic card. The internal LEDs light up to determine the failure.

If none of the LED lights up, the weak battery failure concerns one of the slave posts.

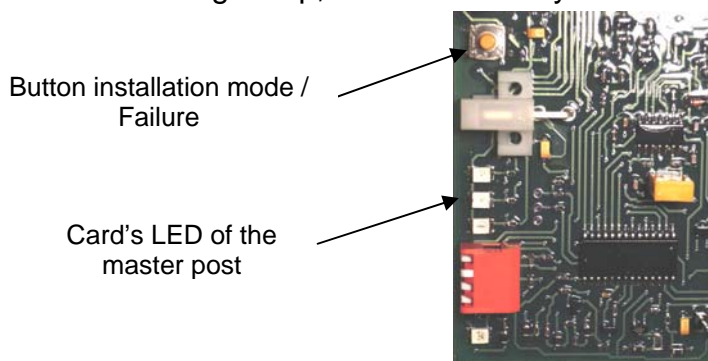

Figure 19 : Button « Installation mode / failure »

**VERY IMPORTANT :** The card's LEDs of the master post light up only if you press the button. The system enters into « installation » mode for 1h30mn.

When you change the batteries, all you need to do is position the magnetic key on the reference mark "activation / deactivation" (see figure 3). The system is then temporarily disarmed (Red LED blinks).

### 7.1 Weak battery indicator of the posts

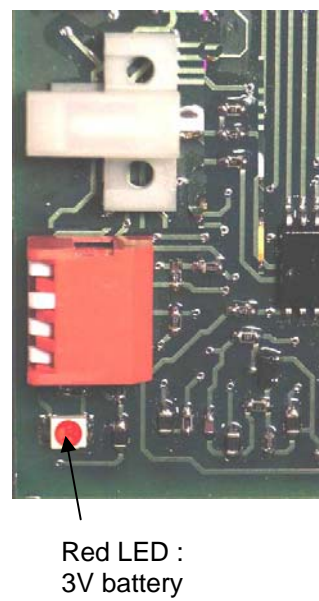
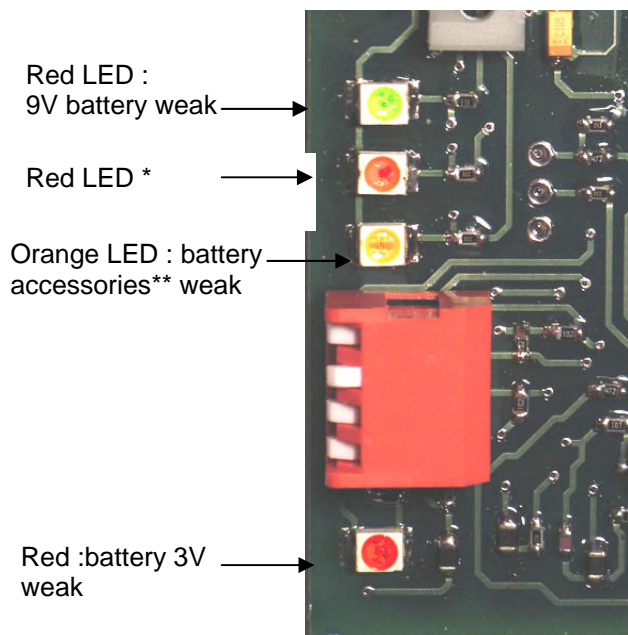

Fig 20 : LEDs “failure” of the master post. Fig 21 :LED “Weak battery” of the slave post

\*Red Led blinks when a failure is detected on the card of the master post.

\*\*Only accessories, bracelets or gate sensor

### 7.2 Weak battery indicator of the accessories

#### 7.2.1 Weak battery of the remote of the keypad :

The LEDs of the remote and the keypad shut off when the batteries are weak.

#### 7.2.2 Weak battery bracelet and gate sensor :

When the batteries of the bracelet or gate sensor are weak, the central emits a beep every 30 seconds and the LED « Failure » of the master post starts blinking.

To identify the failing bracelet or gate sensor, carry out the recognition procedure (§ 6.1) for each accessory. If the recognition procedure is successful, the battery is still operational. If the recognition systematically fails, the accessory with the weak battery has been identified.

If the system continues to emit beeps, it means that another accessory has a weak battery. In that case, repeat the identification procedure.

## 8 MAINTENANCE

It is advised to regularly test the proper operation of the Primaprotect alarm system. Regularly clean the panes of the posts (Warning ! Do not use abrasive products).

The spare parts must be originals or in conformity with the specifications of the NF P 90 307 standard.

### 8.1 Changing the batteries of the safety bracelet

The battery of the sensor bracelet lasts 2 years. If the indicator announces « weak battery bracelet » change the battery (type 3V CR2032) as shown below :

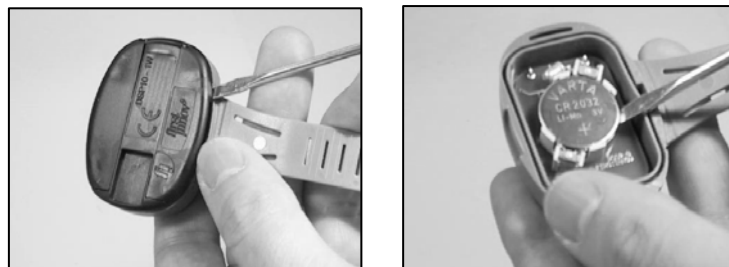

Illustration 22 : Changing the batteries of the sensor bracelet.

### 8.2 Changing the batteries of the remote

The remote control's batteries lasts 2 years. If the indicator announces « weak battery » change the two batteries (type CR1220) as follows :

1. Open the remote with a Phillips screwdriver.
2. Extract the old batteries from its holder and replace them by the new ones (making sure the + marking is facing up). Do not forget to put back the plastic ring that surrounds the batteries).
3. Shut the housing back and test the remote (refer to § 6.3).

### 8.3 Cleaning the panes

For an optimum operation of the system, it is advised to clean the panes of the posts when they 're dirty in order not to block the infra-red beam. Take off the panes as follows :

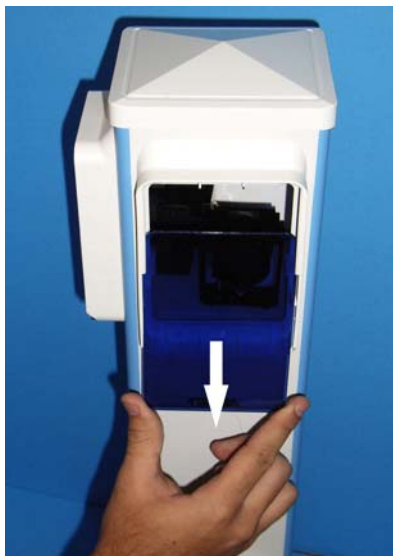

Illustration 23 : Dismounting the panes

Do not wash the post with a large amount of water or a hose. Use a damp sponge.

### 8.4 Cleaning the bracelet

Test the bracelet before each use.

It is important to keep the bracelet clean. Wash the two electrodes with a soft tooth brush, soap and water (Warning ! Do not put the bracelet inside the washer or use abrasive products etc).

## 9 Interpretation of the sounds and visual signals of the alarm system

### Operational system

State of the system	Red LED temporary deactivation	Green LED Monitoring	Audible Sound
Alarm system temporarily deactivated	Blinks	Off	None
Alarm system activated	Off	Blinks	None
System out of service (battery unplugged or wintering mode activated)	Off	Off	None

**Troubleshooting**

<b>Problems</b>	<b>Probable Causes</b>	<b>Solutions</b>
The LEDs of the system do not light up	Battery pack	Check the connexion of the battery packs (9V & 3V)
The siren goes off inopportunoely in" monitoring" mode.	Wrong alignment	Proceed with the alignment.
LED « failure » blinks and an audible sound	Weak batteries	Refer to § 7 failure weak batteries
The siren goes off inopportunoely in temporary deactivation mode	Safety bracelet accidentally wet.	Check the sate of the bracelet.
Impossibility to carry out the recognition or cancel a recognition of an accessory.	Weak battery of the accessory	Identify the weak battery and change it
The sensor bracelet does not work	The electrodes are obstructed Weak battery The distance between the bracelet and the master post is too big.	Clean the electrodes Change the battery Re-examine the installation and the position of the system.

**10 Guarantee, responsibility**

Within 15 days of your purchase, the installation sheet must be signed and returned to FIRSTINNOV, along with the copy of your invoice. The products provided with the Kit Primaprotect (Batteries not included) are guaranteed for two years from the purchase date. If during the guarantee, a product is defective because of a manufacturing defect, FIRSTINNOV will fix or replace (at the appreciation of FIRSTINNOV) the device or its defective parts according to the conditions specified herein. FIRSTINNOV reserves the right to replace the defective products or their spare parts by new products, new parts, or parts revised in the factory. The present guarantee is limited to the replacement of parts recognized as defective by the company FIRSTINNOV. All parts must be returned in their original packaging and shipping costs are at the purchaser's expense.

Dear customer,

Approximately 90% of the returns are due to a wrong utilization of the product that could be easily solved by calling our following number **08 92 259 220** and ask for information or sending an e-mail to : [sav@firstinnov.com](mailto:sav@firstinnov.com)

We would be grateful if you could use these means of contact before returning the device to your supplier. That way, we are hoping to better help you enjoy your product without any inconvenience.

If the product presents eventual defects, please directly contact the retailer where you have purchased the equipment. For this reason, we strongly advice you to keep your invoice.

**After-sales support:**

If you have technical questions, if you need complementary information about our products or if you would like to order spare parts, please contact our after-sales department:

**Opening hours : Monday to Friday From 9am to 6pm**

**Phone : 08 92 259 220**

**E-mail : [sav@firstinnov.com](mailto:sav@firstinnov.com)**

**Important Remark :** Do not return the product to our address before having being invited to do so, by our after-sales department. The non invited products will travel at the risks of the shipper who will support the full expenses of it. FIRSTINNOV reserves the right to refuse the concerned delivery and to return the goods to the shipper at its costs.

***Limits of the guarantee***

FIRSTINNOV reserves the right to refuse its guarantee if the installation sheet cannot be presented or if the information which it must contain appears illegible or incomplete.

The guarantee does not apply if the installation is not fully in conformity with the recommendations given by this guide.

The guarantee does not apply if the model number or if the serial number on the product was modified, erased, removed or made illegible.

The sale by the initial purchaser of the Primaprotect to a third person will cause the loss of the guarantee for the new owner. We will consider that the new owner has accepted this condition.

The guarantee will not be applicable if the product has been modified without prior agreement from FIRSTINNOV

This guarantee does not cover any damage caused by :

- An improper use, including - but not exclusively an inappropriate use of the system or by not respecting the instructions given by the guide for the installation, the use and the maintenance of the product.
- Any repair carried out by the customer himself or by a non approved repairer.
- Various accidents, such as floods, lightning, fire or any other cause exceeding the FIRSTINNOV responsibility.

The guarantee does not cover the usual maintenance and the repair or the replacement of parts that have followed a fair wear and tear (ex: batteries).

***Limits of responsibility***

FIRSTINNOV responsibility is limited to the replacement or the repair of the product or one of its components. The whole responsibility of FIRSTINNOV for any defective product cannot, in any case, exceed the purchase price of the product. FIRSTINNOV will not be held responsible for any other costs, expenses, loss or any damage resulting from the use of the product.

FIRSTINNOV has only an obligation of means: to provide an apparatus in an operating state, exempt from any manufacturing defect. FIRSTINNOV nor its retailers cannot be held

responsible for the fall or the drowning of a child, an adult or an animal in the pool. You remain the only person responsible for the safety of your swimming pool.

The integrated sirens of the central and the optional remote sirens are in conformity with the requirements of the NF P 90-307 standard. FIRSTINNOV nor its retailers can not be held responsible for any problems related to the triggering of the sirens.

The manufacturer and his suppliers decline any responsibility towards any person for any damage or any other claim resulting from a non conform handling of the product or non respect of the safety instructions.

The only authorized change on the product is the changing of the batteries which has to be done at the beginning of each season.

## **11 Safety notice**

It is preferable to let a professional, trained on the Primaprotect product, handle the installation.

The siren must be heard from any location of your home. Depending on the distance between your residence and your pool it might be necessary to add remote sirens in order to be heard from any location of your residence. During the installation, it is imperative to test that you can hear the siren. Extra sirens can be purchased as an option.

The Primaprotect alarm system is an alarm for private unenclosed swimming pools, for individual or collective use which present a danger. The fast intervention of a responsible person is mandatory.

This alarm system is a safety device which announces a danger (or a risk of danger). When the alarm goes off, a responsible adult must intervene in less than 3 min. It is imperative to react as soon as the siren goes off.

The alarm system replaces neither the common sense nor the individual liability. Its purpose is not to replace the vigilance of the parents and/or the responsible adults, which remains the main factor of protection for children under five years old.

The user who deactivates the system must be aware that human monitoring is mandatory. The highest caution from the parents or responsible adults is necessary between the end of the bathing until the reactivation of the alarm system.

In case the siren goes off, do not approach it too closely. Prolonged exposure to an excessive level of sound may cause hearing loss.

Using radio frequency devices that operate in the 434 MHz frequency band (for example wireless head set) will not interfere with the transmission, and will not trigger the alarm. However it may reduce the range of the accessories.

FIRSTINNOV' declines any responsibility for any injury or material damages resulting from the use of the alarm system.

Prevent a child under five years old to access the pool during a failure signal of your system, take all the necessary measures until the problem is fixed.

It is strongly advised to test the bracelet before each use. Keep the remote out of reach of the children and at a minimum height of 1 meter 60.

The safety of your children only depends on you ! The risk is higher for children under five years old. Accidents do not only happen to others! Be ready to face it!



**WATCH AND ACT:**

- The children monitoring must be close and constant around the pool.
- Designate only one person responsible for the safety around the pool.
- Reinforce your surveillance when there are several users in the pool.
- Teach your children how to swim as early and as soon as possible.
- Wet the neck, arms and legs before entering the water.
- Learn the first aid techniques and especially those specific to children..
- Forbid diving and jumping in the presence of very young children.
- Prohibit racing and wild games in the vicinity of the pool.
- Do not authorize the access to the swimming pool without waistcoat or life jacket to any unaccompanied child who does not know how to swim.
- Do not leave any toy near or in the unsupervised pool.
- Take out any attractive floating object from the pool which can encourage children to lean and fall into the water.
- Never leave a child alone by the swimming pool or any water area that are 10 or 20 cm deep.
- Keep the water clean and limpid
- Store water treatment products out of children's reach (Pool chemicals etc....)
- The individual who deactivates the system must realize that human surveillance must take over.
- Forbid access to the pool to young children under five years old during the triggering of a failure signal; take all necessary precautions until it has been fixed.
- Prohibit swimming in your absence

**TO PLAN :**

- Have an accessible phone near the pool in order not to leave children unsupervised while you're on the phone.
- Have a lifebuoy on a pole close to the pool
- Memorize and post up the emergency phone numbers near the pool :
  - Fire brigade: (18 for France)
  - SAMU : (15 for France)
  - Antipoison Centre: .....

**INSTRUCTIONS IN CASE OF AN ACCIDENT :**

- Get the child out of the water as quickly as possible
- Call for help immediately and follow the instructions given over the phone.
- Replace wet clothes with warm blankets

The severity of the drowning depends mostly on the time it took you to find out about the accident, sometimes it takes longer than we think to discover it, due to the initial panic, that prevents the surrounding from acting and starting the first aids (CPR...).

The sticker with the pictogram reminding the adults of their duty to monitor young children and that announces the electronic monitoring of the pool must remain stuck on the central unit by the pool.

Regularly carry out the crossing tests of your Primaprotect alarm system.

## 12 Technical characteristics

Height of the beam :	16cm and 55cm above the ground
Power:	9V and 3V
Siren :	105dBA at1m (+/-5dB)
Lifespan of the 9V battery pack :	1 to 2 years
Lifespan of the 3V battery pack :	1 to 2 years
Lifespan of the batteries of the bracelet:	2 years
Lifespan of the batteries for the remote:	3 years
Radio Frequency transmission :	433.92MHz
Temperature of operation:	-25 to +70°C
Distance between two posts :	minimum 4m and maximum 20m
Alignment angles of the detectors :	±15° horizontal and ± 10° vertical

Primaprotect is compliant with the European Directive R&TTE 1999/5/CE on radio frequency equipments and with the French standard on swimming pool alarm systems NF P 90-307.

### 13 WASTE COLLECTION FOR ELECTRONIC EQUIPMENTS AND BATTERIES



**WARNING**

While replacing the batteries do not touch the printed circuit. Any damage to the printed circuit will not be covered by FIRSTINNOV’s guarantee.

This product is labelled with the symbol indicating separate waste collection for electrical and electronic equipment which means that this product must be recovered by a recognised waste management facility in conformity with the European Directive 2002/96/EC “On Waste Electrical and Electronic Equipment”.

The purpose is to recycle or treat in order to reduce the impact on the environment. For more information please contact your local administration.

The electronic products not subject to a selective waste collection are potentially dangerous for the environment and human health because they may contain dangerous substances.

**Important :** During the replacement of your batteries, we request you to comply with the regulation in place with regards to their elimination. Dispose of used batteries in an environmentally-friendly fashion by using the existing public collection.





**Firstinnov'**

5, rue du Chant des Oiseaux

78360 Montesson France

Email : [dsp10@firstinnov.com](mailto:dsp10@firstinnov.com)

Phone : 08 92 259 220 (0,41 € TTC/minute) <sup>(1)</sup>

(1) Facturation selon les conditions tarifaires de l'OBL de l'appelant – tarifs applicables en France métropolitaine depuis tout poste fixe (hors publiphones)